

JUNJIN CONCRETE PUMP SERVICE INFORMATION



JSI - EN - 05 - 5A - 001	Date	Feb 1st, 2005	
Total Pages	1	Present Page	1
Written by	IL KYU, AN	Approved by	IN JAE, HWANG
Subject	Delivery piston replacement		

■ Replacement cycle

Averagely the replacement cycle of delivery piston(ram) is about 3 months however, the life of the ram might be shorter than the average life depending on the toughness of concrete.

■ Replacement procedure

To move main cylinder rod to the end of its travel, closing the manual ball valve when the piston head is about to reach the end. Loosen fixed bolts and replace the ram.

■ Overloading main cylinder

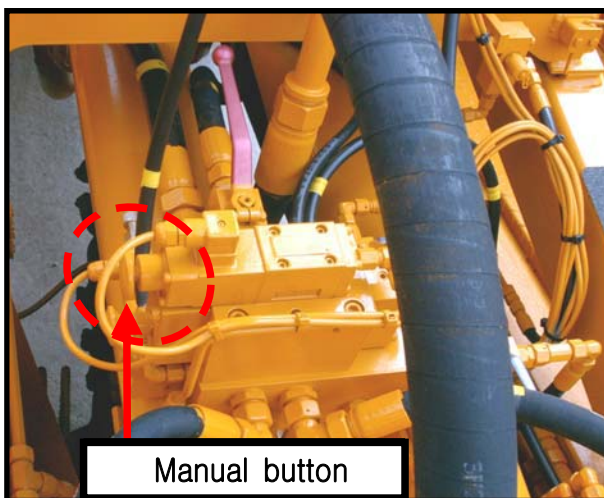

Fig. 1 Solenoid v/v for reverse pumping

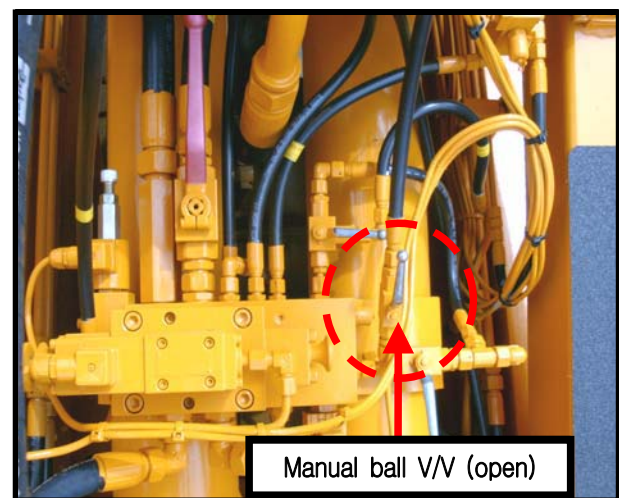

Fig. 2 Manual ball valve

- ① System is overloaded if one of solenoid valve is engaged during pumping.
- ② Main cylinder change-over can not be performed when the manual ball valve is closed.

Caution ① : Accumulator pressure has to be drained for sure when replacing delivery piston.

■ Function of return filter

Hyd. oil returns to the reservoir through the return filter after finishing pumping. The strainer inside the filter should be cleaned up every year or when replace the hyd. oil.

■ Replacement

It should be cleaned up after 100 working hours and replaced after about 500 working hours.

■ Proper procedure for replacement

Open the cover of the return filter housing and replace the element inside.

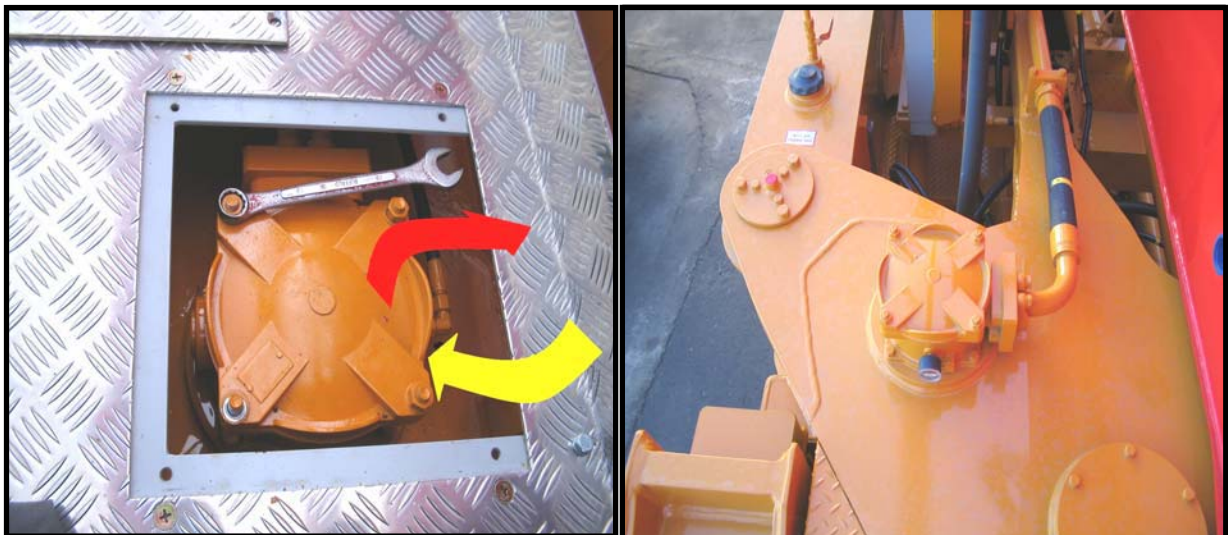

Caution ① : The return filter should be replaced periodically even though the contamination gauge is normal. (Air pressurizing system affects on the contamination gauge)

Caution ② : Be careful not to lose O-ring when replacement.

■ Replacement cycle

Main cylinder rod seals have to be replaced every 6 months. (about 500 working hours) Damage on these seals might cause the contamination of hyd. oil.

■ Possible causes

① Water in the water box has to be replaced every 4 hours especially during summer time. Heated rod of main cylinder might cause the early wear-out of rubber seals.

② When concrete remains and sticks on the surface of main cylinder rod might cause the early wear-out of seals, too. Delivery piston and rod seals have to be replaced at the same time in this case.

③ Keep clean the chrome-coated rod from the concrete and check them when replacing seals or delivery piston.

■ Proper procedure for replacement

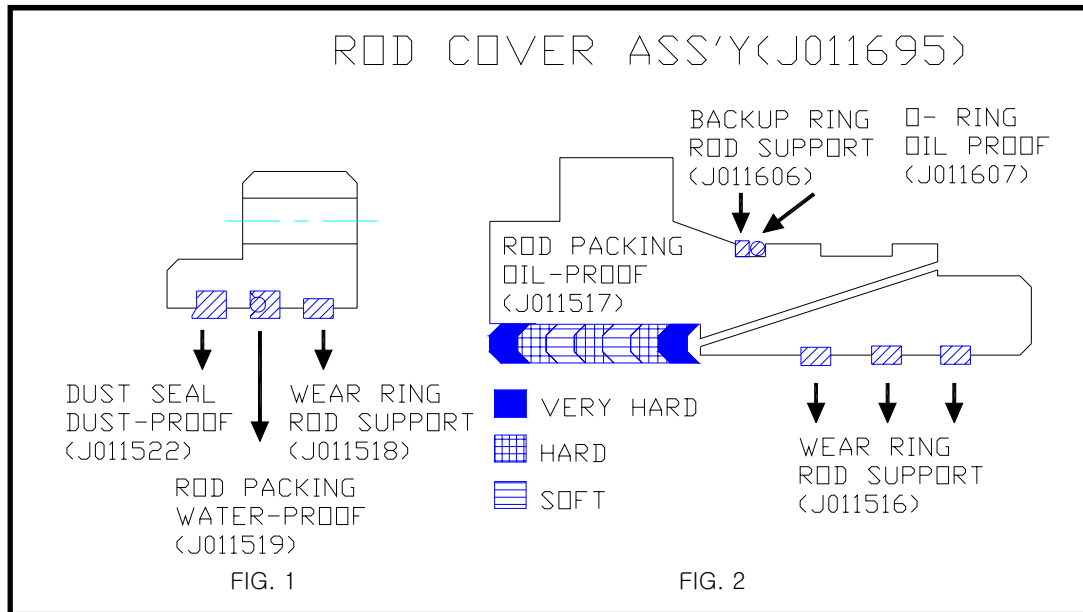

① Move main cylinder piston up to the end of stroke and remove the piston.

② Open the rod cover loosening bolts, then replace dust seal and rod packing as the drawing above.

③ Remove the rod packing inside the cylinder with sharpened tool carefully not to damage on the surface of tube and replace them.

※ Air pressure can be used for easy removal of rod packing inside the cylinder. (using hyd. sensing valve port = passenger side cylinder, using line check valve port = driver side cylinder)

Caution ① : Be careful not to change the assembly order.

Caution ② : Remove the concrete remains from the cylinder rod.

Caution ③ : Some of hyd. oil from lubricating device floats on the water box.

■ Function of bearing flange

Bearing flange supports and protects the auger motor shaft. Mixer shaft might be damaged if bushing and seals are not replaced periodically.

■ Replacement cycle

Bearing flange has to be replaced every 200 working hours or when grease or mortar leaks outside.

■ Proper procedure for replacement

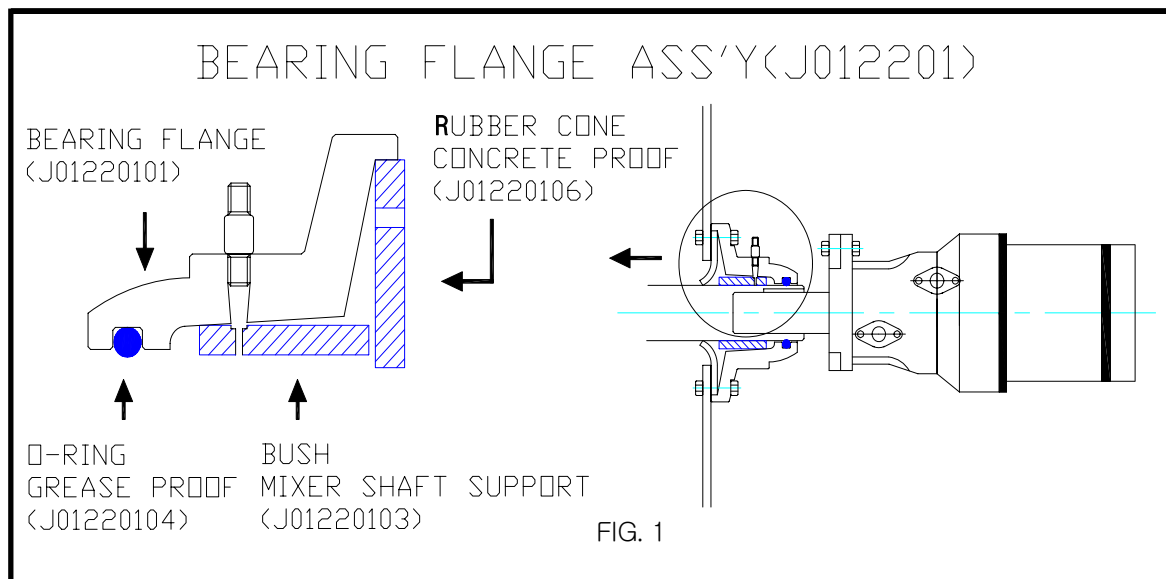

※ O-ring, bushing and rubber cone are assembled as shown above.
If the bearing flange is damaged, it has to be replaced together.

Caution ① : Bolting holes of rubber cone and bearing flange have to be matched.

Subject

O-ring replacement of boom control block

■ Boom control valve system(HAWE)

Boom pump supplies hyd. oil to each cylinder through the boom control valves which control each cylinder proportionally. Main boom control valve section decides boom mode or outrigger mode.

■ Replacement cycle

O-rings have to be replaced when oil leakage is found on each section.

■ Proper procedure for replacement

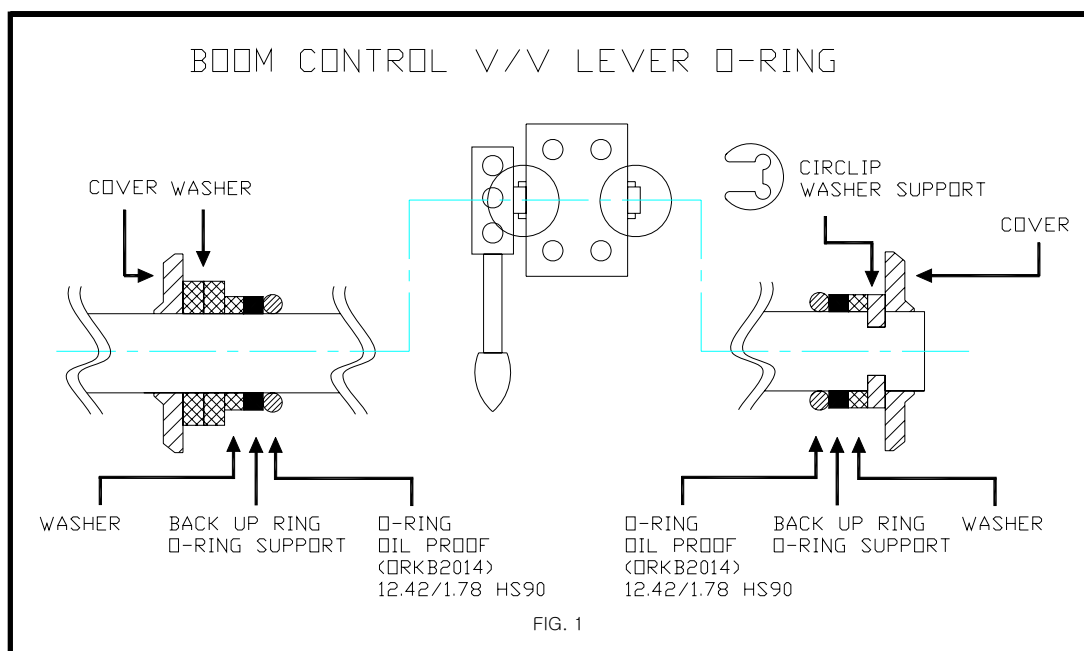

※ Replace O-ring and back-up ring as shown above.

Caution ① : Be careful not to lose spring clip.

Caution ② : Use grease when assembling o-ring and back-up ring.

■ Boom filter

Boom pump supplies hyd. oil to each cylinder through the boom filter.

■ Replacement cycle

Boom filter has to be replaced every 3 months. (about 100 working hours)

It has to be replaced when boom operation is not normal.

(Dirty particles stuck on load holding valve causes the problem with boom control)

■ Proper procedure

Loosen boom filter housing by turning it, then replace the element.

Caution ① : Air-pressurizing system affects on the contamination gauge of boom filter.
Periodical replacement is important.

■ Replacement of wear plate and wear ring

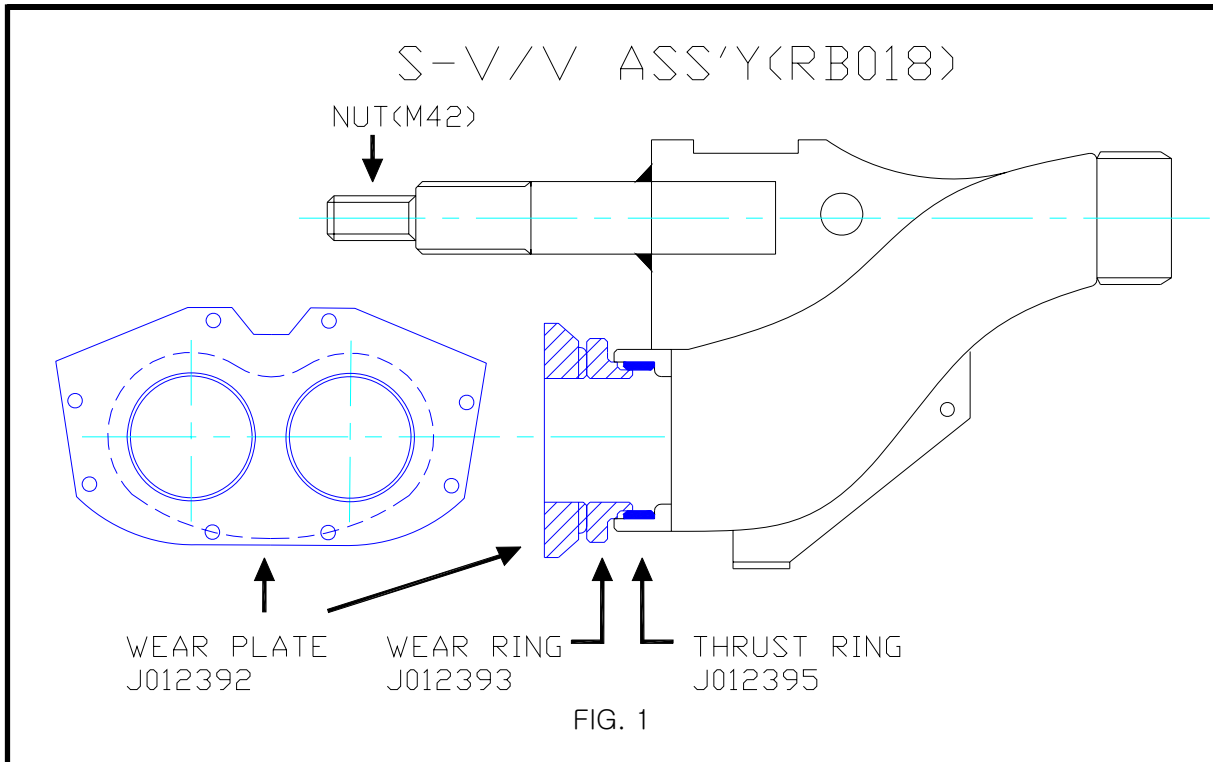

Wear plate and wear ring should be replaced every 1000 working hours.
(about 1 year in Korea)

Replace wear plate and wear ring by loosening the jam nut. (M42)

After replacement of these part, loosen the M42 nut about 30° .(0 - 3mm)

■ Recommended hy. oil

- Summer season in Korea (10° C ~ 30° C)
Viscosity grade=46, Kinetic viscosity range(min=41.4, max=35.2)
- Summer season overseas(30° C ~ 50° C)
Viscosity grade=68, Kinetic viscosity range(min=61.2, max=50.6)
- Winter season in Korea(-10° C ~ 10° C)
Viscosity grade=32, Kinetic viscosity range(min=28.8, max=35.2)
- Winter season overseas(below -10° C)
Viscosity grade=22, Kinetic viscosity range(min=19.8, max=24.2)

■ Replacement cycle

After the first 100 working hours, hyd. oil replacement is recommended.

Hyd. oil has to be replaced every 500 working hours.

If contamination of hyd. oil is found, it has to be replaced.

■ Proper procedure for replacement

2 of oil-drain hoses are located on the both side of tank. Hyd. oil can be drained fast with air pressure. (engaging P.T.O) Clean up the tank and replace filters and oil.

Caution ① : Keep the transmission gear in neutral position when drain oil.

Caution ② : Check the magnet inside tank not to disturb the flow of oil.

Subject

Hydraulic oil replacement

■ Oil tank capacity

NO	Model	P.T.O gear box	Reduction gear	Oil tank	Remark
1	M33	6L		500L	
2	M37	8.4L		620L	
3	Z37	8.4L		620L	
4	M41	8.4L	0.56L	600L	
5	X42	8.4L	0.56L	820L	
6	M43	8.4L	0.56L	850L	
7	M50	8.4L	0.56L	850L	
8	M55	9L	0.56L	850L	
9	HP-MOLI	8.4L		400L	
10	Oil spec.	GS 80W/90	OMALA 150	TELLUS Z46	

Subject

Suction filter replacement

■ Suction filter for accumulator pump

This filter is installed in the suction line to the pump for filtering.

■ Replacement cycle

This suction filter should be replaced every 3 months. (about 100 working hours) Accumulator pump is very sensitive with dirty particles.

■ Proper procedure for replacement

Open the cover of filter , then loosen the black plastic nut and replace the element. Certain amount of oil leaks from the housing, however the check valve failure causes continuous leakage from the housing.

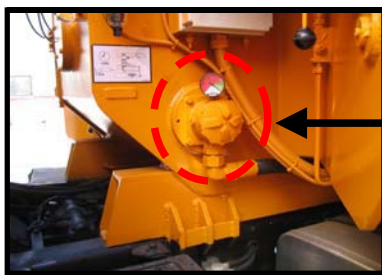

Below M40



Assembly



Over M42



Disassembly

- Caution ① : Air-pressurizing system affects on the contamination gauge of suction filter.
Periodical replacement is important.
- Caution ② : Do not over-torque the plastic nut, it's easily damaged.

■ Replacement cycle

Single layer, heat-treated pipe = about 10,000 M3

Twin layer pipe = 60,000 M3

(depending on concrete and pipe manufacturer)

■ Proper usage of delivery pipes

Turn the delivery pipe for longer use after 100 working hours. In case of main and 2nd section boom they have to be replaced with new pipes, then re-use old pipes to the 3rd and 4th section.

■ Proper procedure for replacement

Loosen the nut of clamp, then assemble pipes and clamps with grease to reduce the resistance.

Caution ① : In case the clamp has a greasing port, it has to be greased every week.

■ function of concrete cylinder

Concrete is delivered to delivery pipes through this concrete cylinder by rubber piston.

■ Replacement cycle

Averagely it should be replaced after 1000 – 1500 working hours depending on the concrete.

■ Proper procedure for replacement

- Remove 2 of delivery piston.
- Support the hopper with forklift or crane.
- Remove the hopper from the concrete cylinder.
(Stud bolts have to be removed)
- Replace the concrete cylinder with new ones.
- If the cross ring is worn out replace them, too.

Caution ① : When removing stud bolts, turnbuckle stud bolt should be removed lastly.

Caution ② : Water-proof adhesive should be spreaded between water box and concrete cylinders.

■ Replacement cycle

Clamps should be replaced for safety when the edge of clamp is worn out not enough to secure the pipes.

Rubber ring should be replaced about every 2 months when concrete leaks from the clamps.

■ Proper procedure for replacement

Loosen the nut of clamp and replace it with new one.

Use grease when replacing rubber ring to reduce resistance.

Caution ① : Remove the concrete remains when replacing.

Caution ② : Avoid replacing pipes during pumping. If necessary, pressure inside the delivery pipes should be removed by reverse pumping.

■ Replacement cycle

Mixer paddle should be replaced when concrete are not mixed well due to the wear-out of paddle.

Mixer shaft should be replaced when it is damaged from the wear-out of bearing flange.

■ Proper procedure for replacement

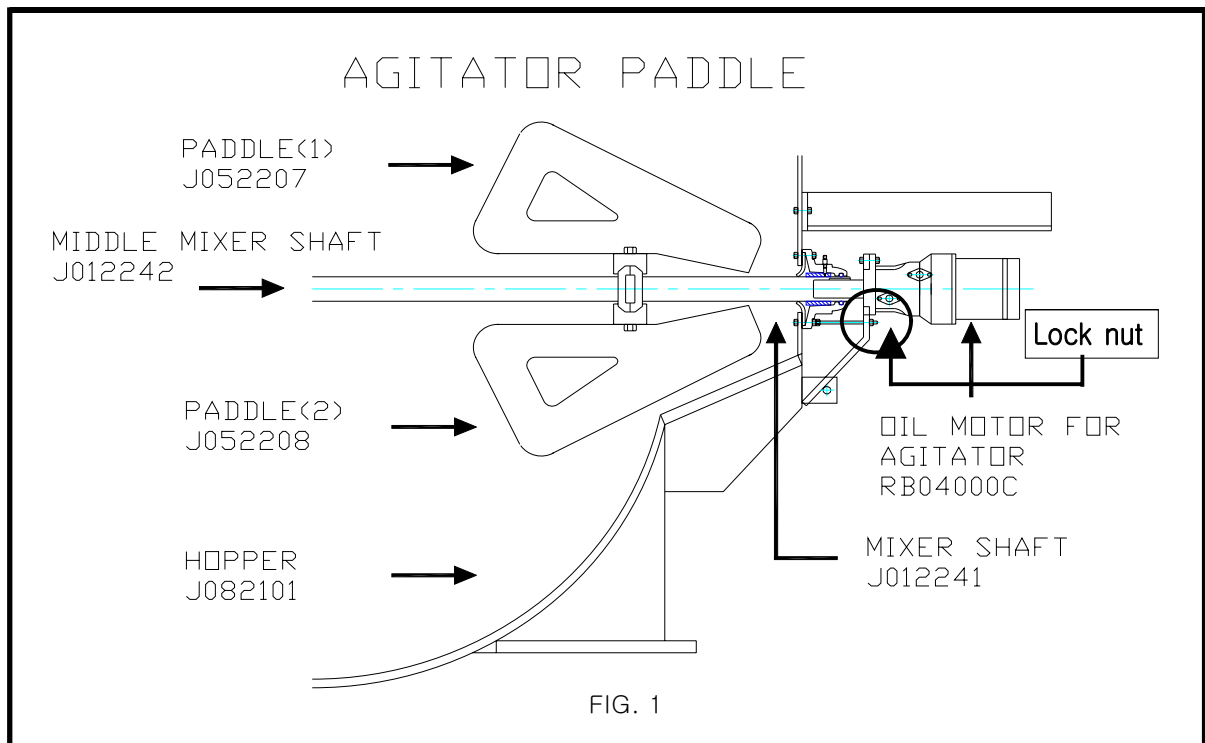

Remove bolts and replace the paddle.

After assembling mixer shaft, loosen the lock nut about 5 - 10mm.

Caution ① : It is important to replace O-ring and bushing of bearing flange periodically.

■ Plunger cylinder

Explosive pressure(190 Bar) is supplied to these plunger cylinders for fast change-over of S-valve. Seals have to be replaced when oil leakage is found between rod and tube.

■ Proper procedure for replacement

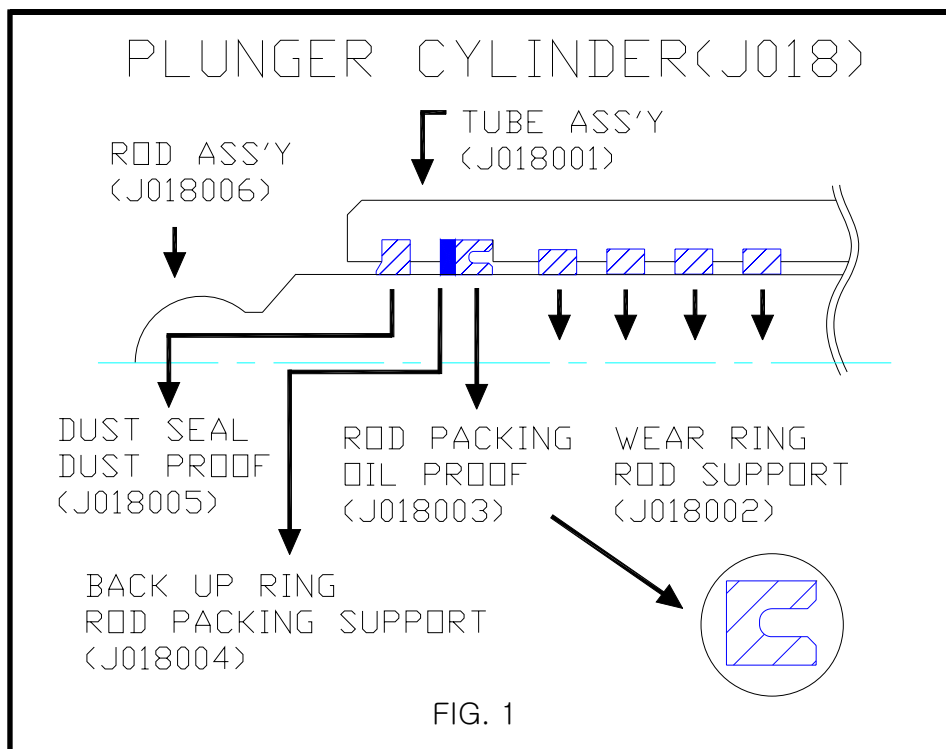

Remove rod from its tube, then replace seals as shown above.

Caution ① : Air pressure and accumulator pressure must be drained for sure when replacing.

Caution ② : Check the direction and order of rod packing.

■ Grease line of seal housing(2)

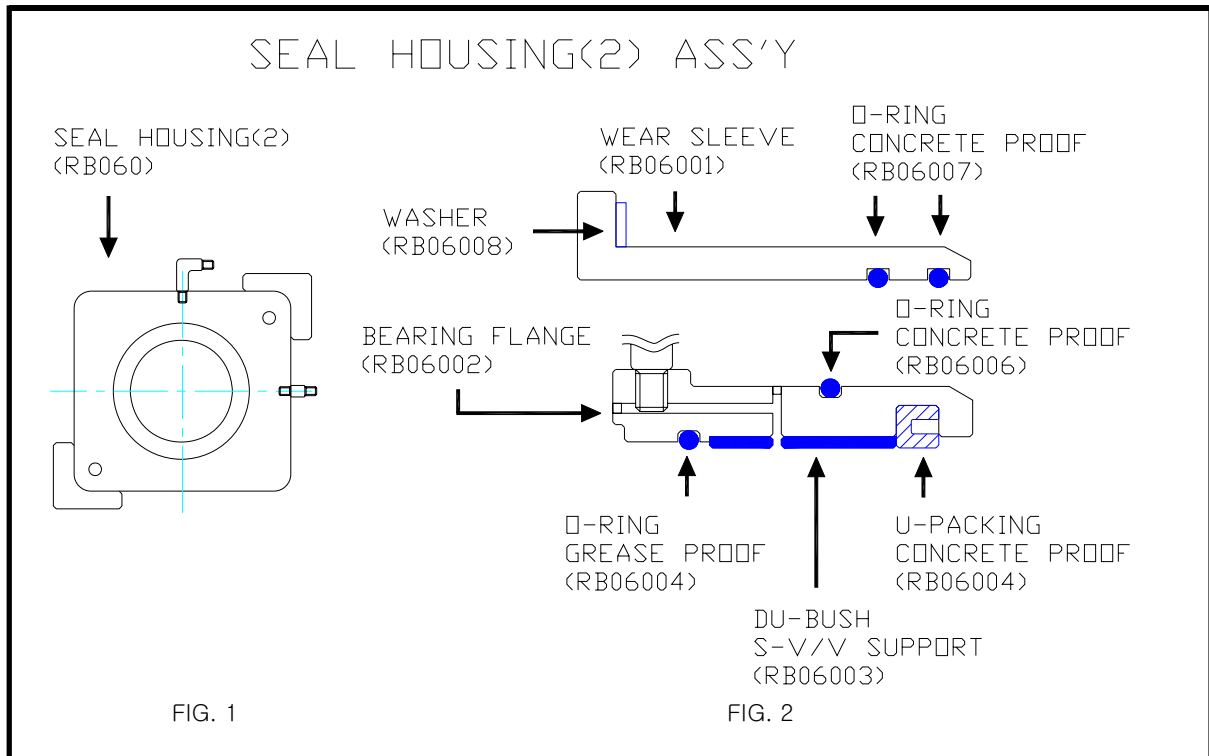

2 of grease line are connected to the seal housing(2). One on the top is greased by the grease pump automatically, the other is manually.

If the grease line on the top is blocked, all grease lines from grease pump are blocked, too. It has to be checked before pumping work and when cleaning.

The grease pump works only when pumping, manual greasing to grease ports is important.

■ Replacement cycle

Seals should be replaced every 6 months averagely. When the grease line is blocked, seals wear out faster.

■ Proper procedure for replacement

When removing the seal housing from the hopper, locate the S-valve vertically from the ground. Check the direction of seals as shown Fig. 2.

Make sure that both stroke of S-valve have to be the same when assembling the seal housing.

Caution ① : Replace S-valve shaft bushing if worn out.

Caution ② : A spring pin has to be inserted between S-valve shaft and swing lever.

Part number reference : Set part number of seal housing is RB0606.

■ Grease line of seal housing(1)

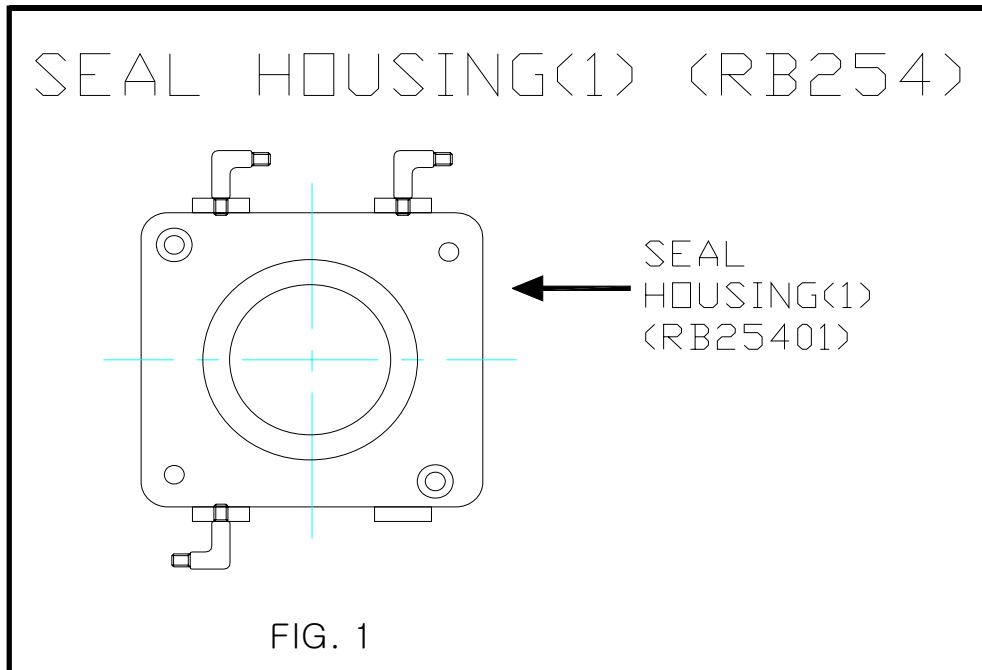

3 of grease line are connected to the seal housing(1). All of grease line are greased by the grease pump automatically. If any grease line is blocked, all grease lines from grease pump are blocked, too. It has to be checked before pumping work and when cleaning.

The grease pump works only when pumping, manual greasing to grease ports is important.

■ Replacement cycle

Seals should be replaced every 6 months averagely. When the grease line is blocked, seals wear out faster.

■ Proper procedure for replacement

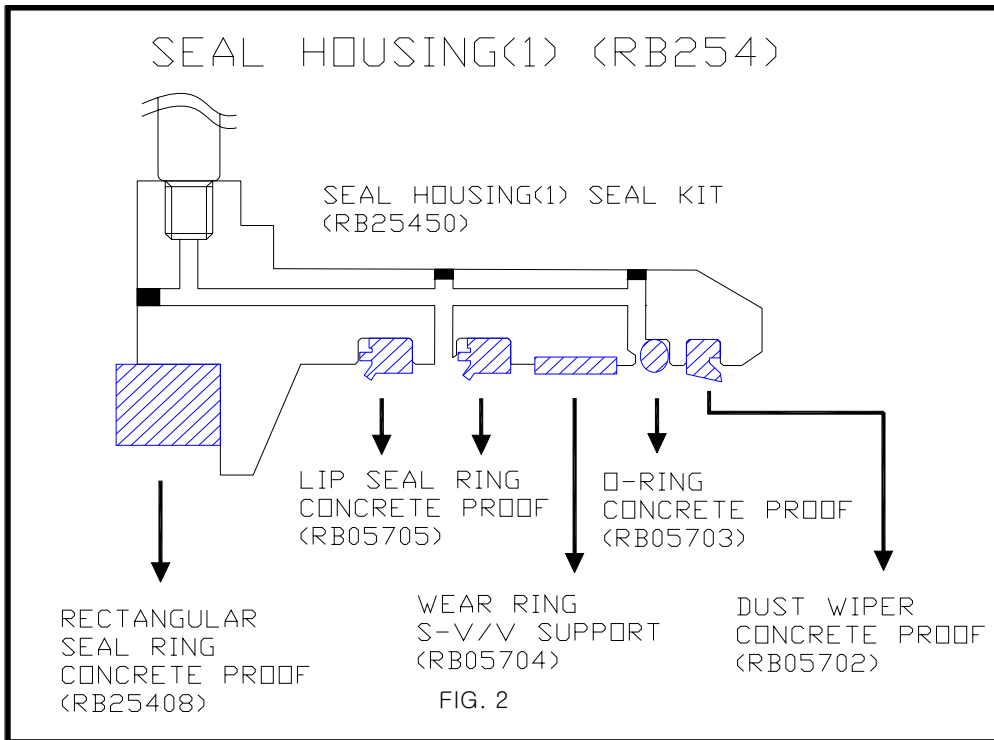

After removing the seal housing from hopper, assemble seals as shown above. If S-valve sleeve is damaged, replace it with new one.

Caution ① : S-valve sleeve has to be heated for a long time.

Part number reference : Set part number of seal housing(1) is RB2545.

Subject

S-valve replacement

■ S-valve change-over

As the plunger cylinder works by the accumulator pressure, the S-valve change-over is performed at the same time.

■ S-valve replacement

Removing both seal housing(1) and (2), then replace the S-valve.

■ S-valve sleeve replacement

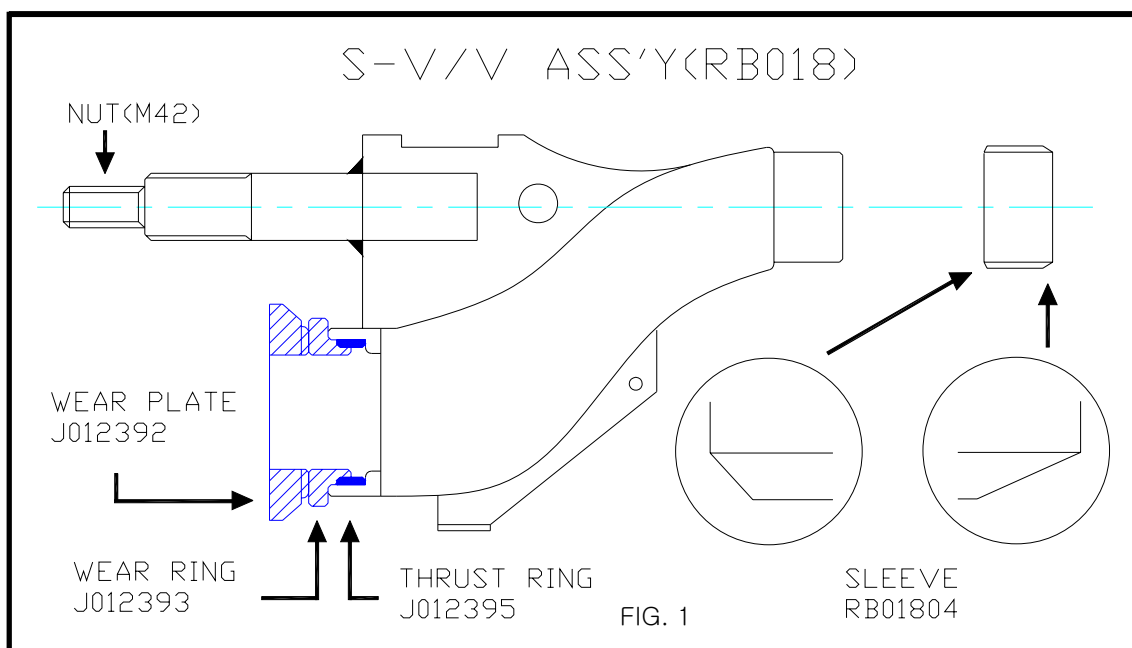

If this wear sleeve is damaged, seal housing has to be replaced together.

Check the edge of wear sleeve when assembling.

Caution ① : The wear sleeve has to be heated for a long time when assembling.